



## PANIC & EMERGENCY EXIT DOORS

### Inside:

- Strand Face Fit Panic Bar
- Strand Face Fit Panic Pad
- Fuhr Concealed Panic Bar Locks - Master & Slave
- Outside Access Kit for Face Fitting & Concealed Panic Bars

**For further assistance, call 01702 613733**

**[www.climatec-windows.co.uk](http://www.climatec-windows.co.uk)**

11-14 Fletchers Square, Temple Farm Industrial Estate, Southend-on-Sea, Essex SS2 5RN

## STRAND FACE FIT PANIC BAR

- Manufactured primarily from steel pressings, with stainless steel latch bolts and zinc alloy cross arm bracket.
- Tested and certified to BS EN 1125:1997 including amendment 1:2001.
- CE Marked and include classification number.
- All devices can be converted from left hand to right hand.
- Standard devices suit doors up to 2650mm high by 1050mm wide; for wider doors the range includes cross arms of 1150mm or 1450mm. Vertical rods are available to suit doors up to 3150mm high.
- Entirely surface mounted except where outside access function is required.
- Not compatible with ali thresholds on double doors.
- Silver

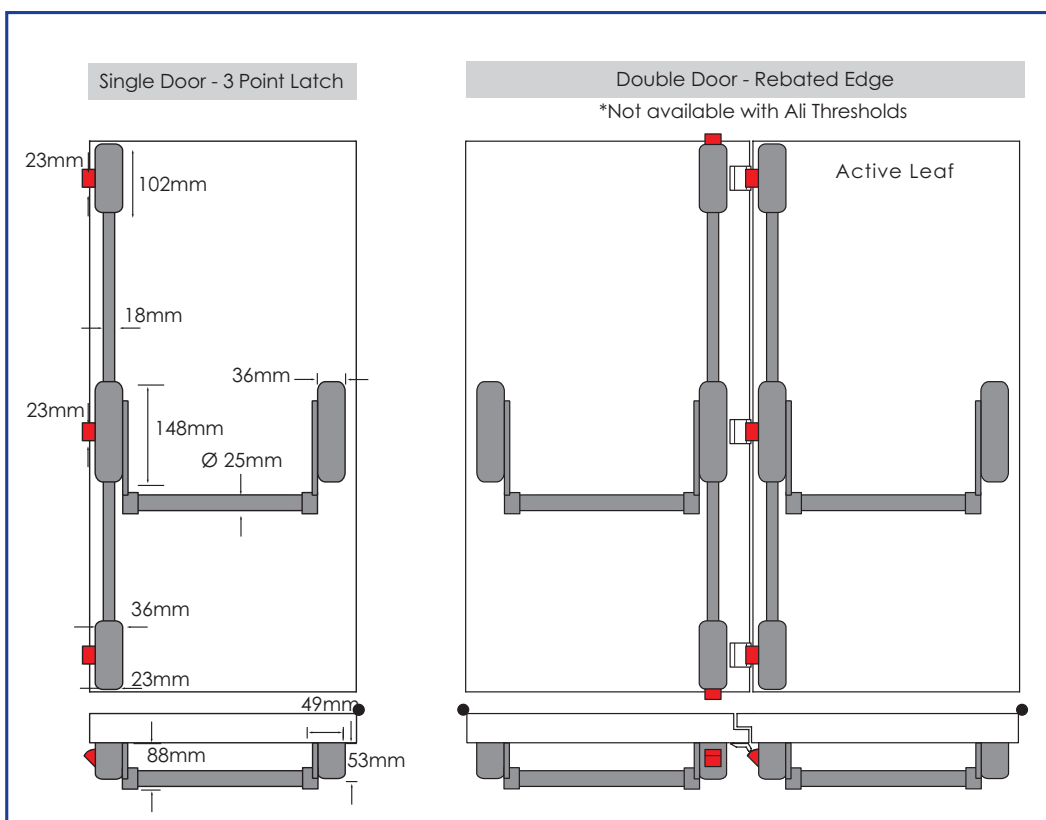
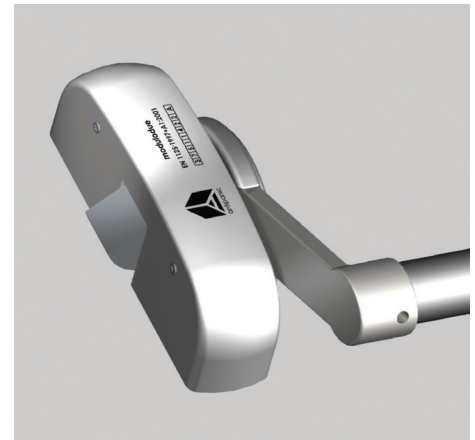

Standard Keep

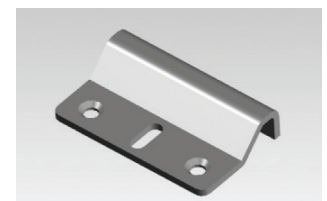

Floor Keep for Ali Threshold  
(not recommended)



For further assistance, call 01702 613733

[www.climatec-windows.co.uk](http://www.climatec-windows.co.uk)

11-14 Fletchers Square, Temple Farm Industrial Estate, Southend-on-Sea, Essex SS2 5RN

## STRAND FACE FIT PANIC PAD

- Manufactured primarily from steel pressings, with stainless steel latch bolts and zinc alloy cross arm bracket
- Tested and certified to BS EN 179:1998 including amendment 1:2001
- CE Marked and include classification number
- All devices can be converted from left hand to right hand.
- To suit doors up to 2650mm high: Extra long vertical rods are available for doors up to 3150mm high
- Entirely surface mounted except where outside access function is required
- Not compatible with ali thresholds on double doors.
- Finishes available - Silver.

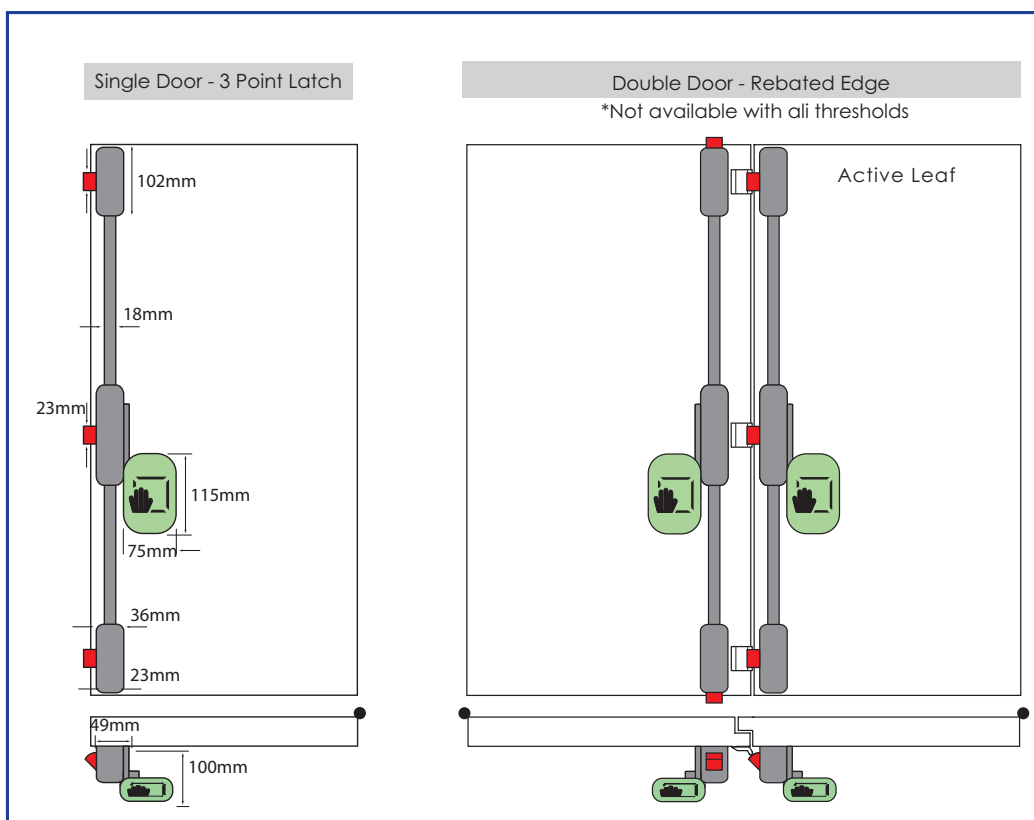

Standard Keep

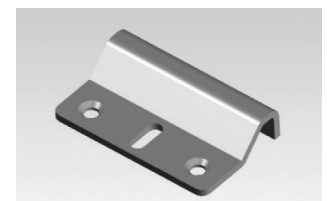

Floor Keep for Ali Threshold  
(not recommended)

**For further assistance, call 01702 613733**

[www.climatec-windows.co.uk](http://www.climatec-windows.co.uk)

11-14 Fletchers Square, Temple Farm Industrial Estate, Southend-on-Sea, Essex SS2 5RN

## FUHR CONCEALED PANIC BAR LOCKS - MASTER & SLAVE

- Multipoint locking system with Panic Exit function
- Reversible latch (non handed)
- Steel round deadbolts 20mm throw with lockout for strength and security
- High security panic door hardware for use on PVCu
- Internal operation via panic bar
- Panic bar finished in RAL 9029 Green
- CE Marked
- External access kit fitted as standard
- Multipoint lock, panic bar and cylinder successfully tested and conform to EN1125
- Classification 37601322A
- Single doors minimum rebate width 700mm, maximum rebate width 1200mm
- Double doors minimum rebate width 1500mm, maximum rebate width 2400mm

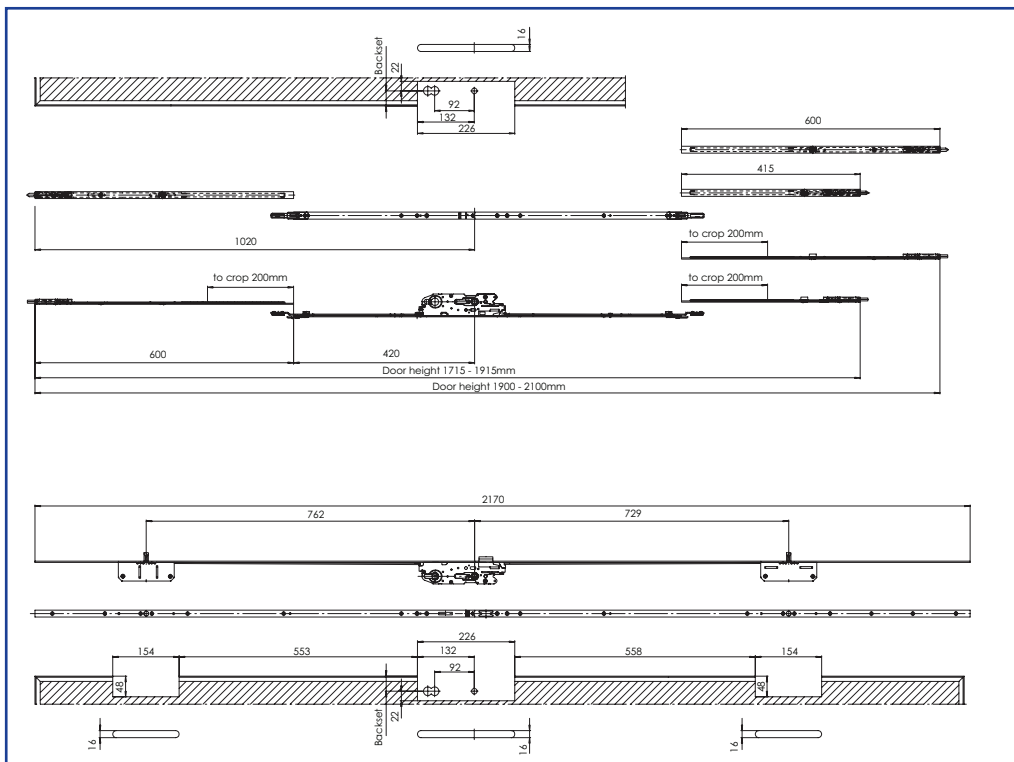

For further assistance, call 01702 613733

[www.climatec-windows.co.uk](http://www.climatec-windows.co.uk)

11-14 Fletchers Square, Temple Farm Industrial Estate, Southend-on-Sea, Essex SS2 5RN

## OUTSIDE ACCESS KIT FOR FACE FITTING & CONCEALED PANIC BAR

### FACE FITTING PANIC BAR - OUTSIDE ACCESS KIT

- Optional outside access device with lever handle
- Only available in silver
- Supplied with a standard 39mm half cylinder

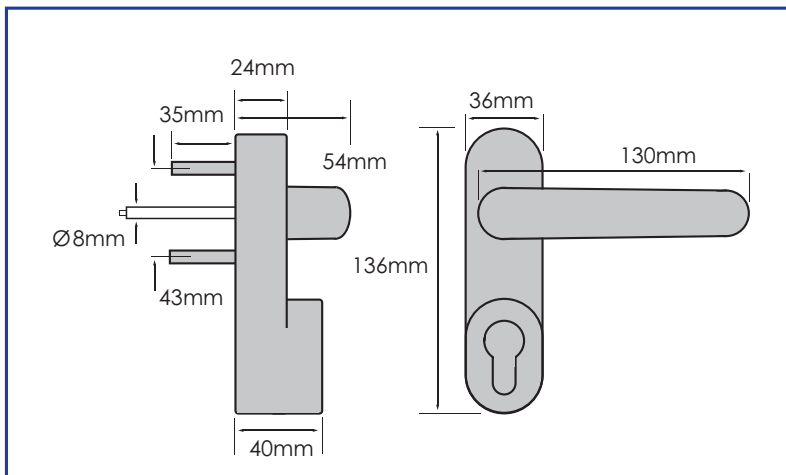

### CONCEALED PANIC BAR - OUTSIDE ACCESS KIT

- Key operated lock with fixed knob handle to allow outside access.
- Only available in silver.
- Supplied with a specialist cylinder.
- Single & double door options available.



**For further assistance, call 01702 613733**

[www.climatec-windows.co.uk](http://www.climatec-windows.co.uk)

11-14 Fletchers Square, Temple Farm Industrial Estate, Southend-on-Sea, Essex SS2 5RN